

Control strategy approach based on the operational results of a small capacity direct air-cooled LiBr-Water absorption chiller

Joan Farnós¹, Jesus Castro¹, Giorgos Papakokkinos¹, and Assensi Oliva

¹ Heat and Mass Transfer Technological Center (CTTC)
Technical University of Catalonia-BarcelonaTech (UPC-BarcelonaTech)
ETSEIAT, C. Colom 11, 08222 Terrassa (Barcelona), Spain
Fax: +34 93 739 89 20 e-mail: cttc@cttc.upc.edu

Abstract

The scope of this paper is to give a short overview of the state of the art regarding control strategies, identify the role of different operating conditions, and provide useful suggestions for the design and operation of a solar assisted absorption cooling system, in line to the European regulation as well as its directly related directives. The operation of a solar absorption cooling system under real conditions is subjected to various limitations regarding its ability to satisfy the required cooling demand, as well as to avoid certain internal conditions which would lead to problematic situations and jeopardize the smooth operation of the system - such as solution crystallization and water freezing. Thus, it is very important to define and refine new control operating strategies, from an internal and external perspective. Several control strategies are discussed, altogether with a new fuzzy logic approach, which shall be experimentally validated as future actions, due to its highly promising capability.

Keywords: *Air-cooled, numerical simulation, LiBr-Water, object-oriented, transient, single-effect, absorption, fuzzy logic, control.*

1. Introduction

In 2005, the Ecodesign Directive 2005/32/EC established a framework aimed at setting the ecodesign requirements for energy-using products. In 2009, the Ecodesign Directive was extended (Directive 2009/125/EC) to all energy-related products (ErPs). Thus, also products which do not necessarily use energy, but have an impact on energy consumption and can therefore contribute to save energy were included.

The most common available technologies that increase the energy efficiency of chillers, and thus help to comply with the normative, are: i) Electronic expansion valves (EEV), ii) Variable capacity compressors, iii) Variable frequency drives (VFD), iv) Evaporative cooling, v) Electronic fans and pumps, vi) Controllers and supervisory systems with energy-efficiency functionalities, and vii) High efficiency heat exchangers (e.g. micro-channels, flooded).

In this paper an extended discussion over the potential use of variable frequency drives is included, aiming to achieve a great performance of the chiller under different operating challenges. In fact, an intelligent operation of the absorption chiller may result in an adequate performance, together with a minimization of operating interruptions (freezing, crystallization, etc.).

Internal and external controls must be focused on the operation of air-cooled absorption chillers. In this work internal chiller processes are addressed by reviewing several control strategies present at the scientific literature and also from the industry. External control deals with external parameters of the chiller, such as the ones concerning low, medium and hot circuitry.

Controlling hot and cooling water is one of the most promising approaches but in a direct air-cooled machine is highly complicate, at least at the medium focus. Nevertheless, an optimal control of the chiller concerns on defining a good strategy for the whole system, including heating and cooling components (hot and cold storage, solar circuit, etc.).

The principal controlled parameters of a solar cooling system may be inner hot water temperature and mass flow, cooling air or inner water temperature and mass flow, and chilled water outer temperature and mass flow. Chilled water must be kept in certain limits to allow satisfactory operation (Kohlenbach and Ziegler, 2008). At

the same time differential on/off operation of the external circuits should be avoided (Bong et al., 1987) (Yeung et al., 1992) (Labus et al., 2012).

Directly focusing on the direct air-cooled absorption chillers, these are attractive due to it is not necessary both cooling tower either the associated installation. However, the key technical barrier to operate an air-cooled absorption chiller using LiBr-Water as working fluid is crystallization because of high temperatures achieved inside the absorber which derives in a concentrated solution. It is the main difference towards water cooled absorption chillers. As air is used as coolant, low heat transfer characteristics must be taken into consideration because operational concentrations of the solution are very close to the crystallization limit. Therefore, not always the evaporator temperature can be maintained as low as it would be necessary to overcome the absorption pressure increase. LiBr begins to crystallize when the temperature solution is reduced under the crystallization limit or when concentration ratio is increased.

When high condensation temperature is required due to high ambient temperature (Florides et al., 2003) (Izquierdo et al., 2004), high temperature at the desorber is needed, with a possible overloading power to the desorber. Therefore, a high concentrated solution has to return to the absorber through the solution heat exchanger. On the other hand, for condensation temperatures over 40C, single-stage air-cooled absorption chillers cannot be operated by single glaze flat plate collectors (McNeely, 1979).

Other causes which allow the creation of slush are low ambient temperature and full load, electrical failure (shutdown dilution process) and when the chilled temperature is set too low (Liao and Radermacher, 2007). The presence of non-absorbable gases (air and hydrogen) which may vary according to the power input at the desorber and their effect on the performance of the absorption process phenomena have previously been studied at a basic research level (Garcia-Rivera et al, 2008, 2011, 2012, 2016). The effect on the performance of the chiller will be discussed in future works on the performance of the air-cooled absorption prototype.

Air leaks into the system raise the evaporating temperature and the chilled water leaving temperature. A higher temperature increases the heat input and the solution concentration to the point of crystallization. When the system is operated at full load, if the temperature of the cooling water is too low, the diluted solution temperature may fall low enough to reduce the temperature of the concentrated solution to the point of crystallization. If the electric power is interrupted, the system ceases to operate. The temperature of the concentrated solution in the heat exchanger starts to drop and may fall below the crystallization line.

Because of the particular operating principle of absorption chillers, novel and imaginative integration strategies have been proposed in the literature and shortly reviewed next. Several devices have been developed in order to minimize the possibility of crystallization. Moreover, several approaches can be found on the scientific literature as self-decrystallisation technique (DeVuono et al., 1991) by driving high temperature secondary fluid through the solution heat exchanger. It is only possible if high temperature drives the desorption process. Other techniques as controlling the absorbed mass by monitoring the fluid level at the evaporator or boosting the absorber pressure have also been studied by different authors (Zogg and Westphalen, 2006), (Xie et al., 2012). These approaches and an overview of control strategies can be found at Labus PhD dissertation, (J. Labus, 2011), where a new Artificial Neural Network (ANN) modeling and optimization approach is described. Another focus is to define a control strategy based on minimizing specific costs or the price for generation of cold (J. Albers, 2014).

A J-tube technology or by-passing the solution from the desorber to the absorber in order to avoid crystallization is widely applied on the industry [18], (Wang et al, 2011). When crystallization phenomena appear, a connection between the desorber and the absorber, which by-passes the solution heat exchanger, is opened. Therefore, immediately the concentrated solution is diluted and its temperature decreases, warming the low concentrated solution. At the same time, the mass flow over the solution heat exchanger will allow to avoid crystallization at the concentrated solution which is at low temperature.

Summarizing, regulation and control of the cycle is quiet challenging due to crystallization phenomena and environmental temperature dependence. In fact, mass flow driven from the generator to the absorber depends on the pressure gradient, which at the same time depends on the geometrical configuration. Therefore, it is important the mechanical design in order to define correctly all the input parameters at the numerical simulation. Transient numerical modeling helps to define an optimum control strategy.

Therefore, switch-on, standard operation and shut-down process must be aware not only of delivering cooling to overcome the cooling demand but on the protection of the components, i.e. the solution pump, to avoid

unexpected interruption of the machine and possible warnings (i.e. freezing). Several potential internal and external control strategies must be analyzed, and the authors have implemented different control strategies at the numerical platform tool called NEST (in-house developed object-oriented numerical tool) (López et al, 2012). The readiness of the chiller to deliver cooling demand is also considered, depending on the load demand and operating boundary conditions of the chiller. Operational data of a small capacity single-effect air-cooled LiBr-Water absorption chiller has been obtained and presented in this paper.

2. Numerical approach of the control strategy

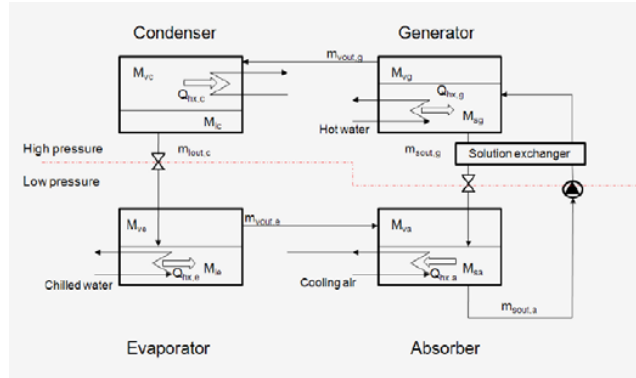

Fig. 1. Basic diagram of a single effect LiBr-H₂O absorption chiller based on parallel configuration

For performing the simulations a modular object-oriented simulation platform named NEST has been used, allowing the link among different components (solar field, pumps, tanks, heat exchangers, absorption chiller, etc.). In this numerical platform each component is an object, which can be an empirical-based model (e. g. heat exchangers, solar collector), lumped capacity models or a more detailed calculation if necessary. With this numerical platform, parallel computing is allowed. This model plant is capable to simulate the thermal and fluid dynamical behavior of the whole air-cooled absorption chiller (Farnós et al., 2017a, 2017b).

Numerical control strategy has been implemented considering a wide variety of causes which may interrupt the operation, basically in terms of crystallization and freezing. In fact, internal and external controls must be focused on the operation of air-cooled absorption chillers. External control deals with external parameters of the chiller, such as the ones concerning low, medium and hot secondary circuits.

Controlling hot and cooling water is one of the most promising approaches, but in air-cooled machines it is not possible, at least at the medium focus. However, an optimal control of the chiller is based on defining a good strategy for the whole system, including heating and cooling components (hot and cold storage, solar circuit, etc.). A multivariable approach presents a high performance control capability. The main controlled parameters of a solar cooling system may be water inlet temperature and mass flow at low, medium and high source.

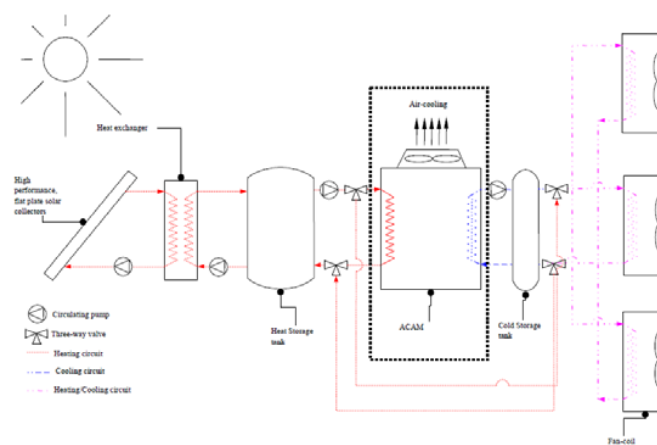

Fig.2. Solar cooling facility implemented in a virtual facility

Regarding the main technical characteristics of the secondary circuitry, the total considered solar area is 30m² with flat plate collectors with an efficiency of: $\varepsilon = 0.803 - 2.4 \frac{T_{in} - T_m}{G} - 0.0058 \frac{(T_{in} - T_m)^2}{G}$. The cold water tank has a capacity of 1000 liters, and the hot water tank 5000 liters. Finally, the auxiliary source has a thermal power of 20 kW.

3. Technical Characteristics of a direct air-cooled absorption machine

A small, compact and cost-effective single-effect LiBr-Water absorption chiller has been designed, prototyped and commissioned not only from a scientific perspective but from an end-user perspective at the Heat and Mass Transfer Technological Center from the Technical University of Catalonia (UPC-BarcelonaTech). The use of standard components and procedures from the whole assembly has been mandatory during the whole development. The arrangement between the air-cooled heat exchangers is in parallel flow. The absorber takes more than the 50% the total air flow, the same proportion as the frontal area. All the heat exchangers have been divided in two parts in order to keep the design as compact as possible. On the other hand, and based on the EU regulation control approaches must also be focused and discussed.

Table 1. Equipment specifications and main results of the cycle simulation (* output value)

	Units		Specification	
Nominal capacity	kW		7.0	
COP	-		0.7	
Hot water stream	°C	kg h ⁻¹	88	1730
Cooling air stream	°C	m ³ h ⁻¹	35	16500
Chilled water stream	°C	kg h ⁻¹	9	1200

4. Analysis of the performance of the chiller under different control strategies

Data obtained from numerical simulation is used to manage the regulation based in a transient analysis, taking into account several heat and mass transfer phenomena like absorption, desorption, evaporation condensation etc., aiming to assure an acceptable performance of the chiller under different operating conditions, etc. Therefore, a great effort was done by obtaining mass transfer coefficients, which feed the transient numerical simulation, by solving the falling film phenomena in detail. Furthermore, thermal size of the components is not fixed but obtained in each time step (Farnós et al., 2017a, 2017b). Monitoring the performance focusing on heat rejection temperature dependency and crystallization phenomena is a very valuable data to reconsider state-of-the-art strategies where air is not the most common used coolant.

In order to regulate the cooling capacity of the chiller according to the cooling demand, different strategies can be attended. The first one may be the regulation of the mass flow of the secondary stream at the desorber. Nevertheless, figure 2 demonstrates that the regulation of the cooling capacity becomes a challenge using this strategy because the delivered cooling mainly depends on the rate of the mass flow on the interval 0-25% of nominal mass flow. Between 25-75% of nominal flow the variation of cooling capacity is around 7-9% only. It agrees perfectly with scientific literature (Zamora et al, 2015).

On the other hand, and based on temperature regulation of the secondary source of the desorber, an other control strategy has been focused (Figure 3). Even though it shows a great potential, in a real solar cooling facility is not easy to implement due to the thermal inertia of the heat storage tank (a tank is used to storage heat when the solar circuit is not activated and to use as minimum as it would be possible the auxiliar heat source; a gas boiler). Therefore, temperature variation can not be reached in a short time in order to follow the cooling demand.

Finally, a third strategy is attended with the aim of following the cooling demand varying the air mass flow of the secondary sources at the absorbers and condensers. An accurate fuzzy logic control shows enough potential to analyze the chiller performance within different operational conditions of the chiller and improve the capabilities of the system, avoiding internal failures and reducing electricity consumption.

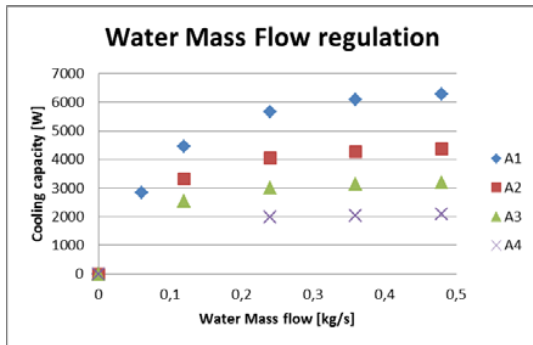

Fig. 3 Water mass flow regulation (*)

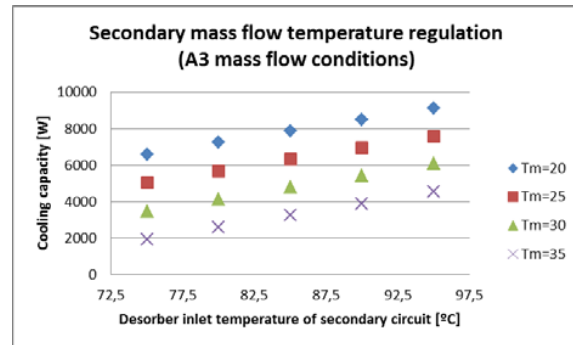

Fig. 4 Secondary mass flow temperature (Desorber) (*)

(*) Secondary nominal mass flows are:

A1: i) Desorber 0.48 kg s^{-1} , ii) Absorber 2.5 kg s^{-1} , iii) Condenser 1.5 kg s^{-1} , and iv) Evaporator 0.334 kg s^{-1} .

A2: i) Desorber 0.48 kg s^{-1} , ii) Absorber 1 kg s^{-1} , iii) Condenser 0.6 kg s^{-1} , and iv) Evaporator 0.334 kg s^{-1} .

A3: i) Desorber 0.48 kg s^{-1} , ii) Absorber 0.6 kg s^{-1} , iii) Condenser 0.36 kg s^{-1} , and iv) Evaporator 0.334 kg s^{-1} .

A4: i) Desorber 0.48 kg s^{-1} , ii) Absorber 0.36 kg s^{-1} , iii) Condenser 0.216 kg s^{-1} , and iv) Evaporator 0.334 kg s^{-1} .

4.1 Air mass flow regulation

Here in this section are presented the results of a parametric analysis of the chiller (Figure 4). Secondary air mass flow streams have been varied from A1 to A4 conditions. Furthermore, a variation of the inner hot water temperature at the generator altogether with the environmental temperature is also presented. Different cooling capacities under different boundary conditions are obtained. Analyzing plotted results it is obvious the necessity of a well-performing control approach, which should be aligned with the EU regulations.

A first basic approach based on switching the operation of the secondary impellers has been considered and presented in Section 5. Nevertheless, it is important to match the cooling load with the cooling capacity, maintaining the internal and external conditions inside the working range and avoiding operating failures. It is the reason why a new fuzzy logic control strategy approach is described in Section 6 of this paper, as well as some examples for a transient operation of the chiller in Section 7.

Table 2: Parametric study: range of operation

Inlet T conditions secondary circuit [°C]	Desorber	Absorber and condenser	Evaporator
Range	75-95	20-35	14

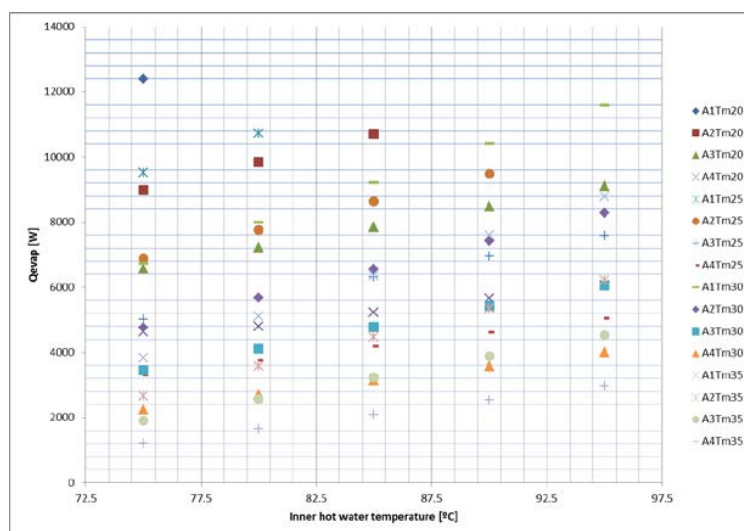

Fig. 5. Parametric study of the cooling capacity of the chiller under different mass flows and temperatures

An other interesting aspect is to analyze the performance of the chiller under different air flow regimes and temperatures, but for a fixed inner hot water temperature. In Figure 5 the cooling capacity over the frequency variation of the fan is presented, showing the wide range that the chiller can overcome under different cooling demands under different medium focus boundary conditions.

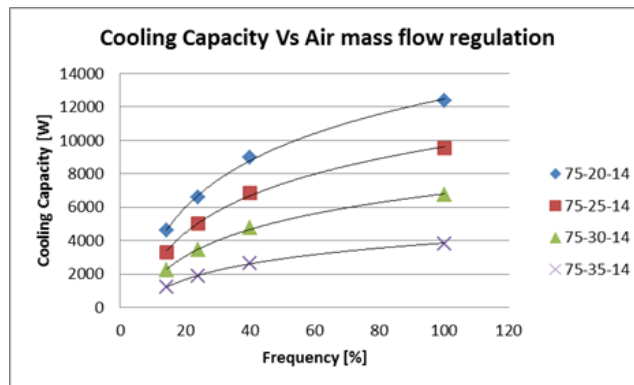

Fig. 6 Cooling capacity under frequency impeller variation

5. Basic control regulation: On/Off approach

Next it is shown the basic control diagram for an On/Off control approach. It is based on the WFC10 from Yazaki [25] and modified according to the direct air-cooled chiller necessities. Nevertheless, a basic On/Off control approach would lead into internal problems and cause failure operating conditions, and is not possible to achieve a high value of the electrical COP.

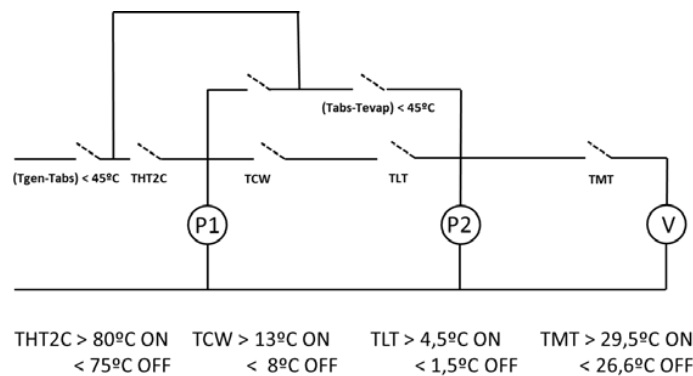
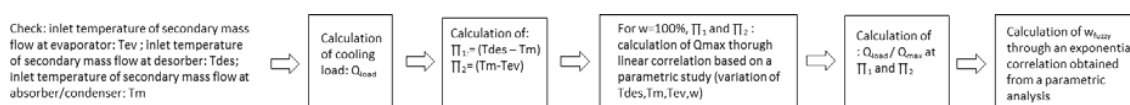

Fig. 7. Basic electric control diagram of the secondary circuitry

6. Basic fuzzy logic control strategy

A new fuzzy logic control of the cooling capacity of the chiller is based on the impossibility to modify the inlet secondary temperatures but having different cooling demands to satisfy. Therefore, in order to avoid processes of freezing or crystallization is important to know which is the maximum capacity of the chiller for each boundary conditions, aiming to change its capacity among the whole frequency range of the air impeller. This basic control strategy is compared to that widely used in other types of chillers based on switching the solution pump between ON and OFF operation (C.P. Underwood, 2015), and presented in Section 7.

A basic algorithm is presented next in order to achieve a high quality cost-competitive control strategy based on a basic sampling temperatures at the secondary circuits.



Equations related to obtain the output value of the fan frequency (w_{out}) are detailed next:

$$\pi_1 = T_h - T_m \quad (1)$$

$$\pi_2 = T_m - T_l \quad (2)$$

$$\dot{Q}_{max} = f(\pi_1, \pi_2, w_{max}) \text{ (Linear correlation)} \quad (3a)$$

Equation (3) is obtained by defining secondary mass flows and keep them constant. Then cooling capacity is obtained for different temperature conditions (a parametric numerical analysis has been carried varying inner hot water temperature from 75°C to 95°C and environmental temperature from 20°C to 35°C).

Once the cooling capacity has been calculated, eq. 1 and eq. 2 are used to calculate temperature differences. Finally, a relation between cooling capacity for arbitrary temperature conditions and the maximum cooling capacity obtained from the parametric study allows to obtain the value of the cooling ratio (Q/Q_{max}) for arbitrary conditions. Finally a correlation between π_1 and π_2 and Q/Q_{max} is obtained. The maximum error between the correlation and the Q/Q_{max} values obtained from the numerical simulation is lower than 2%, allowing to move forward on this control strategy approach.

$$Q_{wmax} = (0,059226879 + 0,019855119\pi_1 - 0,025693839\pi_2) Q_{ref} \quad (3b)$$

$$w_{out} = f(\dot{Q}_{demand}, \pi_1, \pi_2) \text{ (Exponential correlation)} \quad (4a)$$

Equation (4) has also been obtained by means of a parametric study of the prediction of the performance of the chiller under different boundary conditions (See Fig. 4).

$$w = 5.3145e^{2.9126(Q_{demand}/Q_{max})} \quad (4b)$$

The inner hot water temperature range varies between 75-95°C and the environmental temperature oscillates among 20-35°C. Then, for fixed mass flows over the secondary circuitry (Block A1,A2,A3 and A4) the cooling capacity is calculated for the whole temperature range defined. Then, defining T_h, T_m and T_l the cooling capacity per block is obtained. Moreover, the maximum cooling capacity is referenced to the A1 block, but this Q_{ref} can also be either the nominal expected cooling capacity (7kW) or correspond to the maximum cooling capacity that the chiller is capable to deliver for a fixed T_h, T_m, T_l . Then, the cooling ratio is calculated (Q/Q_{max}). Q/Q_{max} ratio is almost the same for all the same temperature case (fixing T_h, T_m, T_l); varying the frequency of the air impeller.

Finally Figure 7 plots the cooling ratio versus the frequency of the impeller. Defined temperature conditions altogether with a variation of the air mass flow can oscillate the cooling capacity of the chiller, which will allow to follow the cooling demand, reducing the electricity consumption and avoiding internal challenges.

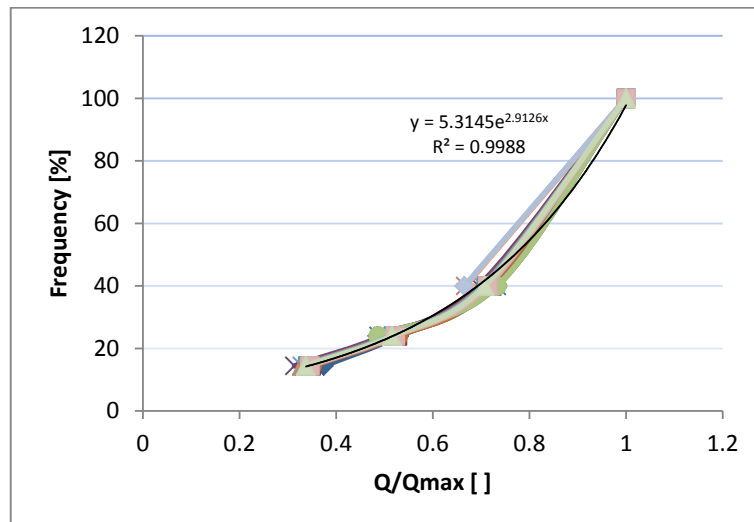

Fig. 8 Normalised exponential function (eq. 4)

7. Control demonstration: application, basic, fuzzy logic, and no control approach

A virtual laboratory has been created in order to analyze a solar cooling facility. Evaporator and generator secondary stream inlet temperatures are determined by two sinks, which are used as a buffer, in order to avoid oscillations on the driving temperature. Temperature inside the tanks is controlled so that the high temperature circuit (solar circuit) is activated only when is required. Hysteresis of the tanks is considered when the high temperature source is activated or deactivated. Moreover, there is an auxiliary circuit if solar circuit is not available to overcome heating demand. The low temperature circuit is controlled in order to avoid freezing at the chiller. In the figure 8 it is described:

7.1 Transient numerical simulation using a basic control strategy of the chiller

A characteristic day (8th July) in Barcelona (Spain) has been simulated in order to understand the performance of the chiller under different control approaches. In Fig. 8 the basic control described in Section 5 has been applied, and thermal power along 24h is plotted, according to a variable cooling demand of a house. It is observed that there are many switches which do not allow the system to operate in the best conditions, and achieve high energy savings. Nevertheless, it permits a very easy implementation on the electrical control device.

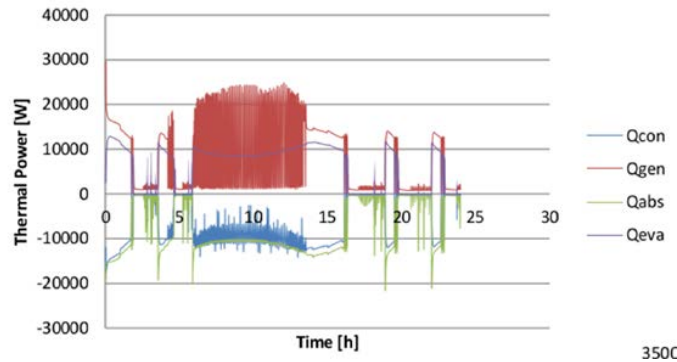

Fig. 9. 24h simulation based on a basic control strategy

7.2 Fuzzy logic control strategy of the chiller (application example):

In this section an example of how the fuzzy logic is applied is shown. Linear and exponential correlations described above are used.

Table 3: Example of a control strategy application

Qdemand [W]	Th [°C]	Tm [°C]	T [°C]	(Th-Tm) [°C]	(Tm-Tl) [°C]	Qmax[W] (w=100%)	Qload/Qmax (w=100%)	Wout [%]	Qdelivered [W]
7000	90	30	14	60	16	10404	0,67	37,41	7000

7.3 Transient numerical simulation using a fuzzy logic control strategy

The fuzzy logic approach described above allows the system to reduce dramatically the energy consumption as well as to follow the cooling demand in an optimal way. Thus, internal challenges are reduced drastically and mean electrical COP is quite larger than the one obtained by using a basic control approach. In future works these values will be presented and compared.

For the same case presented in section 7.1, the performance of thermal power are smoother than using the implemented basic approach. It means that the operation of the chiller becomes easier as well as its potential to avoid internal and external failures. Nevertheless, all these control strategies must be improved and experimentally validated.

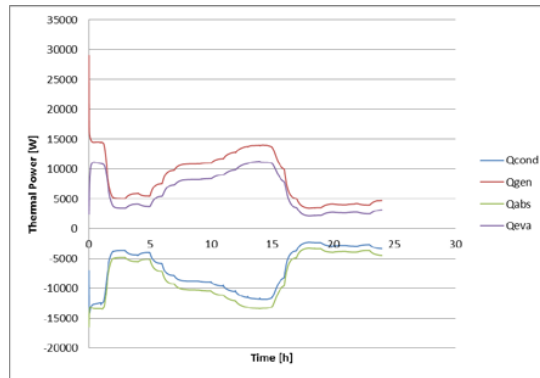

Fig. 10. 24h simulation based on a novel fuzzy logic control strategy

7.4 Comparison between a basic and a fuzzy logic control strategy

In figure 11 the evolution of the electrical COP is presented (same case than in Section 7.1 and 7.3). It is clear that using a fuzzy logic approach the COPel is higher than the one achieved by means of a basic control strategy. Large electricity consumption would be expected to be saved by means of this novel approach.

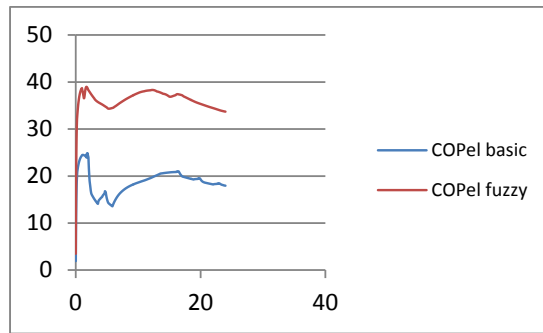

Fig.11 24h COPel evolution

7.5 No control approach

Based on a numerical simulation carried in May for half a day (12h), from 8 am to 8 pm, after 5 hours of a control-based operation (1pm), control is switched-off. Initial basic and fuzzly logic control both have been plotted before switching-off the control device. Then it is shown what would happen regarding freezing and crystallization after basic and fuzzy logic control during the first 5 hours of operation. In the first case we can observe in Fig. 12 the evolution of the primary evaporator temperature after the control is switched off. On the other hand, in Fig. 13 it is described the evolution of the concentration of the LiBr-Water solution inside the desorber vessel. Freezing and crystallization phenomena appear as internal failures. These may damage the absorption chiller operation, being impossible to avoid and leading to operating interruptions if no control strategies are considered, at least in a direct air-cooled absorption chiller.

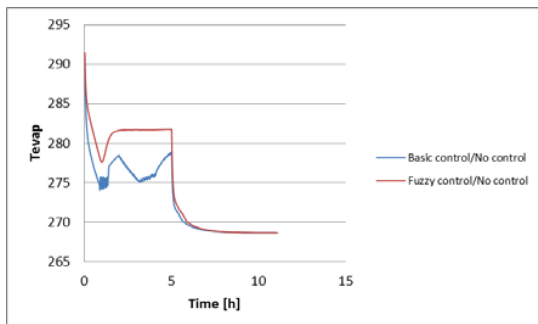

Fig.12 Internal failure if no control is considered (freezing)

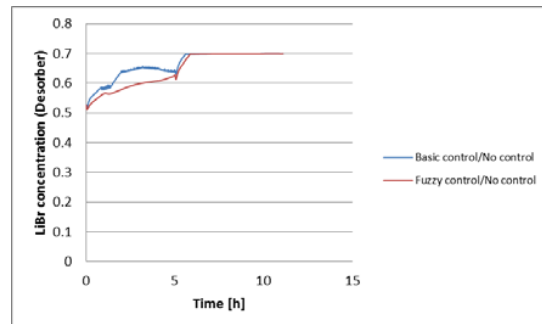

Fig. 13 Internal failure if no control is considered (crystallization)

8. Conclusions

In this work a dynamic model for an air-cooled H₂O-LiBr absorption machine has been used as the basis to implement different kind of control strategies. The model is based in the use of heat & mass transfer empirical correlations of the scientific literature, to avoid ad-hoc adjusts of the main parameters of the absorption refrigeration cycle.

Targeted end users of the absorption chiller must be enlarged in order to go further than domestic applications if an acceptable Return of Investment (ROI) wants to be achieved. In that sense several actions should be performed: increase of the temperature lifts to allow its operation as a heat pump, active/ passive improvements for heat & mass transfer, optimization of transient response, reduction of the total circulating mass flow, and new control strategies to optimize the performance of the chiller and the whole solar cooling facility. Based on this issue and taking into consideration EU regulation, different control approaches of the absorption chiller are herein presented and discussed: i) Inner hot water mass flow regulation, ii) Inner hot water temperature regulation, iii) Basic control regulation, and iv) A novel fuzzy logic control strategy applied to direct air-cooled absorption chillers.

A fuzzy logic approach seems to be the most valuable control strategy, keeping in mind that a multivariable approach, considering inner hot water mass flow regulation, should be focused in the near future. As it has been shown in Fig. 11 the obtained COP_{el} based on the fuzzy logic control strategy is clearly higher than the one obtained by means of a basic control strategy. Internal and external behavior are also smoother than a basic control, which help to avoid operation failures such as freezing or crystallization. Therefore, this tool is recommended to be numerically assumed and experimentally validated in further works, quantifying the total energy savings in terms of thermal load and electricity consumption.

9. References

- [1] P. Kohlenbach and F. Ziegler. A dynamic simulation model for transient absorption chiller performance. Part ii: numerical results and experimental verification. *International Journal of Refrigeration*, 31:226-233, 2008.
- [2] T.Y. Bong, K.C. Ng, and Tay A.O. Performance study of a solar-powered air-conditioning system. *Solar Energy*, 39(3):173-182, 1987.
- [3] M. R. Yeung, P. K. Yuen, A. Dunn, and L. S. Cornish. Performance of a solar powered air conditioning system in Hong Kong. *Solar Energy*, 48(5):309-319, 1992.
- [4] J. Labus, I. Korolija, L. Marjanovic-Halburd, Y. Zhang, and A. Coronas. ANN application to modelling and control of small absorption chillers. In *Proceedings of the BSO12 - Building Simulation and Optimization Conference.*, pages 245-252, 2012.
- [5] X.H. Liao and R. Radermacher. Absorption chiller crystallization control strategies for integrated cooling, heating and power systems. *International Journal of Refrigeration*, 30(5):904-911, 2007.
- [6] GA. Florides, SA. Kalogirou, SA. Tassou, and LC. Wrobel. Design and construction of a LiBr-water absorption machine. *Energy Conversion Management*, 44:2483-2508, 2003.
- [7] M. Izquierdo, M. Venegas, P. Rodríguez, and A. Lecuona. Crystallization as a Limit to Develop Solar Air-Cooled LiBr-H₂O Absorption Systems Using Low-Grade Heat. *Solar Energy Materials and Solar Cells*, 81(2):205-216, 2004.
- [8] L. McNeely. Thermodynamic Properties of Aqueous Solutions of Lithium Bromide. *ASHRAE Transactions*, 85(1):413-434, 1979.
- [9] E. García-Rivera, J. Castro, J. Farnós, and A. Oliva. Two Mathematical Models of the Falling Film Absorption in Vertical Tubes. In *Proceedings of the 8th IIR Gustav Lorentzen Natural Working Fluids Conference*, pages 263-270, 2008.
- [10] E. García-Rivera, J. Castro, J. Farnós, and A. Oliva. Simulation of Absorption of H₂O in Falling Film of LiBr Aqueous in Vertical Tubes in Wavy Regime. In *Proceedings of the International Absorption Heat Pump Conference 2011*, pages 59-66, 2011.
- [11] E. García-Rivera, J. Castro, J. Farnós, and A. Oliva. Modeling of absorption of h₂o vapor in falling film of LiBr aqueous solution in vertical tubes with presence of non-condensables. In *Proceedings of the 10th IIR Gustav Lorentzen Conference on Natural Refrigerants*, 2012.

- [12] E. García-Rivera, J. Castro, J. Farnós, and A. Oliva. Numerical and experimental investigation of a vertical LiBr falling film absorber considering wave regimes and in presence of mist flow. *International Journal of Thermal Sciences*, 109:342-361, 2016.
- [13] A.C. De Vuono, W.T. Hanna, R.L. Osborne, and D.A. Ball. Development of a double-effect air-conditioner heater (DEACH). phase 3 and final report. Overall project report by Battelle and Gas Research Institute., Phase 3 and Final Report, January 1990-December 1991. Phase 3, September 1987-December 1991.
- [14] R. A. Zogg and D. Westphalen. Developing Air-Cooled LiBr Absorption for Light Commercial Combined Heat and Power Applications. *International Journal of Heat Ventilation Air Conditioning and Refrigeration Research*, 12(3b):731-747, 2006.
- [15] G. Xie, Q. Wu, X. Fa, L. Zhang, and P. Bansal. A novel lithium bromide absorption chiller with enhanced absorption pressure. *Applied Thermal Engineering*, 38:1-6, 2012.
- [16] J. Labus. Modeling of small capacity absorption chillers driven by solar thermal energy or waste heat. PhD thesis, Universitat Rovira i Virgili, 2011.
- [17] J. Albers. New absorption chiller and control strategy for the solar assisted cooling system at the German federal environment agency. *International Journal of Refrigeration*, 39:48-56, 2014.
- [18] <http://www.johnsoncontrols.com>.
- [19] K. Wang, O. Abdelaziz, P. Kisari, and E. Vineyard. State of the art review on crystallization control technologies for water/LiBr absorption heat pumps. *International Journal of Refrigeration*, 34(6):1325-1337, 2011.
- [20] J. López, O. Lehmkuhl, R. Damle, and J. Rigola. A parallel and object-oriented general purpose code for simulation of multiphysics and multiscale systems. In *Proceedings of the 24th International Conference on Parallel CFD*, 2012.
- [21] J. Farnós, G. Papakokkinos, J. Castro, and A. Oliva. Dynamic simulation of an air-cooled LiBr-water absorption chiller based on variable heat and mass transfer coefficients. In *Proceedings of the International Sorption Heat Pump Conference*, pages 1-3, 2017.
- [22] Farnós, J., Papakokkinos, G., Castro, J., and Oliva, A. 2017. Dynamic modelling of an air-cooled LiBr-H₂O absorption chiller based on heat and mass transfer empirical correlations. 12th IEA-Heat Pump Conference.
- [23] M. Zamora, M. Bourouis, A. Coronas, and M. Vallés. Pre-industrial development and experimental characterization of a new air-cooled and water-cooled NH₃-LiNO₃ absorption chiller. *International Journal of Refrigeration*, 45:189-197, 2014.
- [24] C.P. Underwood. Fuzzy multivariable control of domestic heat pumps. *Applied Thermal Engineering*, 90:957-969, 2015.
- [25] Manual de Instalación. Grupo refrigerantes por absorción de agua caliente WFC10 Yazaki. ESESA

Appendix: Units and Symbols

Table 4: Symbols

Quantity	Symbol	Unit
Mass flow rate	\dot{m}	kg s ⁻¹
Heat flow rate	Q	W
Temperature	T	°C
Frequency	W	Hz
Temperature difference	Π	°C
ε	Efficiency	
G	Solar radiation	W/m ²
THT2C	Thermostat of inner hot water temperature	°C
TCW	Thermostat of temperature of chilled water	°C
TLT	Thermostat of low water temperature of primary circuit	°C
TMT	Thermostat of air mass flow temperature	°C
P1	Pump 1. Chilled water pump	
P2	Pump 2. Hot water pump	
V	Fan	
COP	Coefficient of Performance	

Table 5: Subscripts

Quantity	Symbol
des	Desorber
h	High temperature focus
m	Medium focus (environment)
l	Low temperature focus
cond	Condenser
gen	Generator
abs	Absorber
evap	Evaporator
max	Maximum
in	Inlet value
out	Outlet value
demand	Demand
ref	Reference
el	Electrical
th	Thermal
1	Hot-medium focus temperature difference
2	Medium-low focus temperature difference